

NBS Specification

L10 - Windows / Rooflights / Screens / Louvres
460 - Rooflights

Manufacturer : Whitesales Europa House Alfold Road Cranleigh GU6 8NQ
Tel 01483 271371 Fax 01483 271771 E-mail sales@whitesales.co.uk

Product Reference : Em-Dome and Em-Curb

Type : Dome

Size : Specify from Product literature

Frame : Screwbolt - High security

Kerb : Em-Curb PVCu 300s. Height 300mm

Material : PVCu - white self finish

Glazing details : Polycarbonate double skin

Finish : Specify from Product literature

Other requirements : PVCu opening frame and manual spindle

Fixing : Please consult Whitesales for recommendations

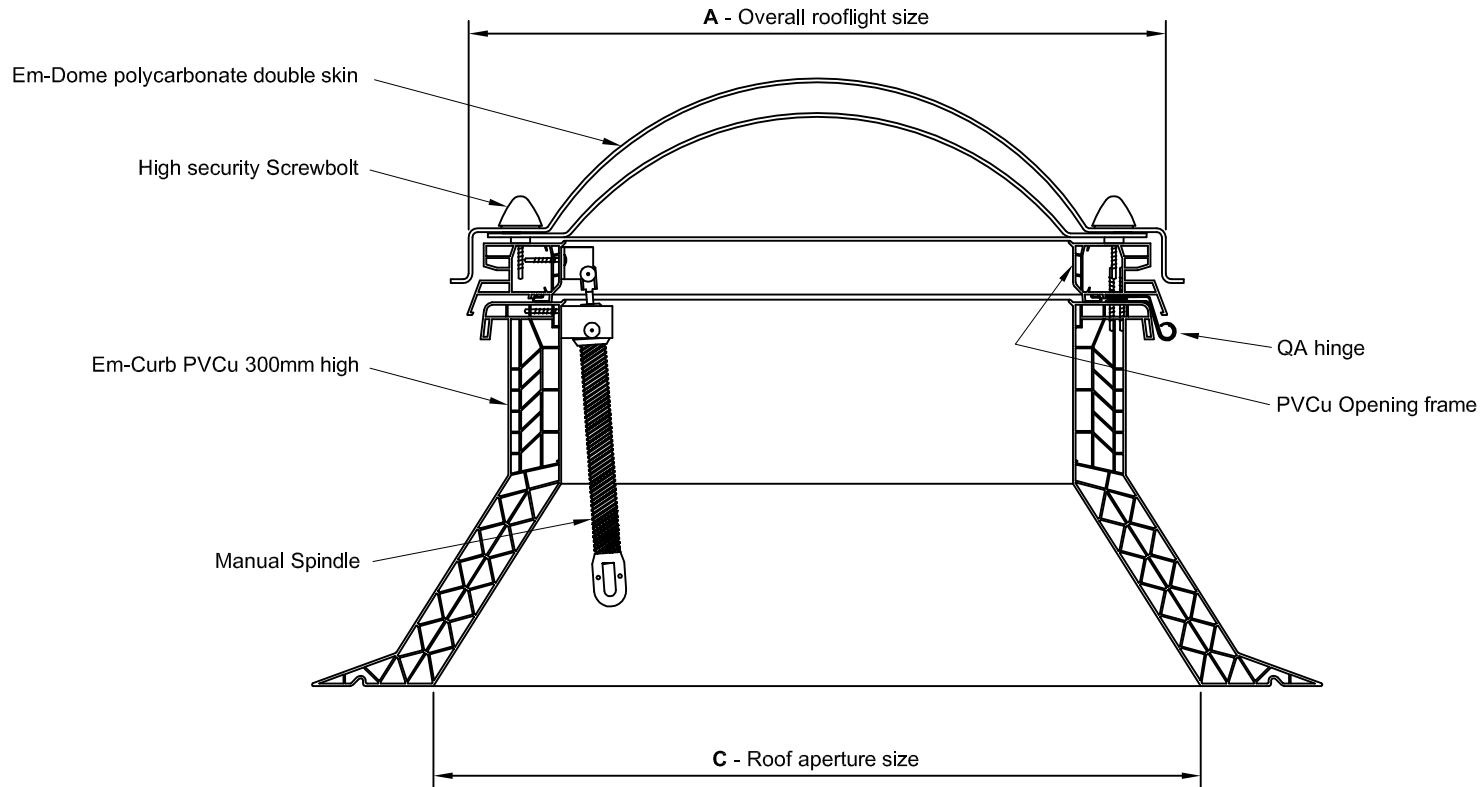

WHITESALES

DRG No 0552

Em-Dome polycarbonate double skin rooflight
complete with splayed Em-Curb PVCu 300mm high
and PVCu opening frame and manual spindle
installed to prepared roof aperture